

SERIAL NUMBER: Q/KR.C09-05-186

JIANGMEN KREALUX ELECTRICAL APPLIANCES CO., LTD				MODEL NO: P02-4			
DRAWN		DATE		EDITION	A	SCALE	1.8:1

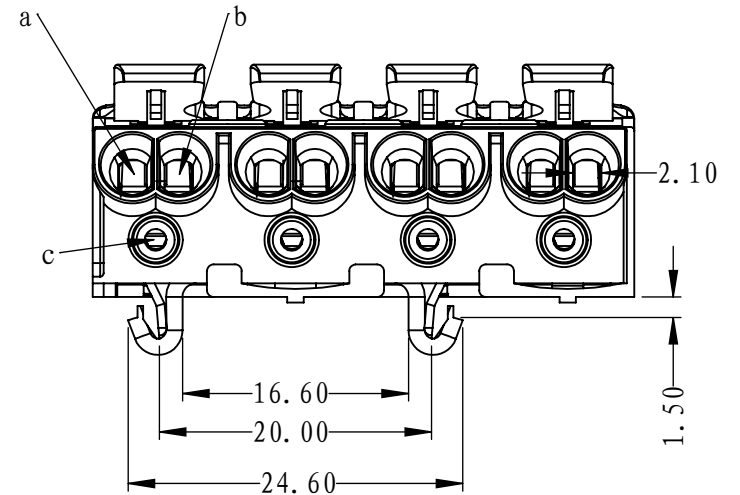
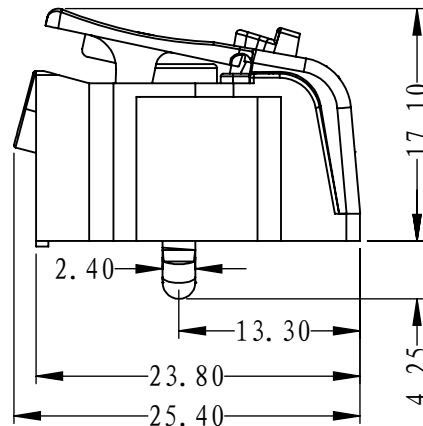
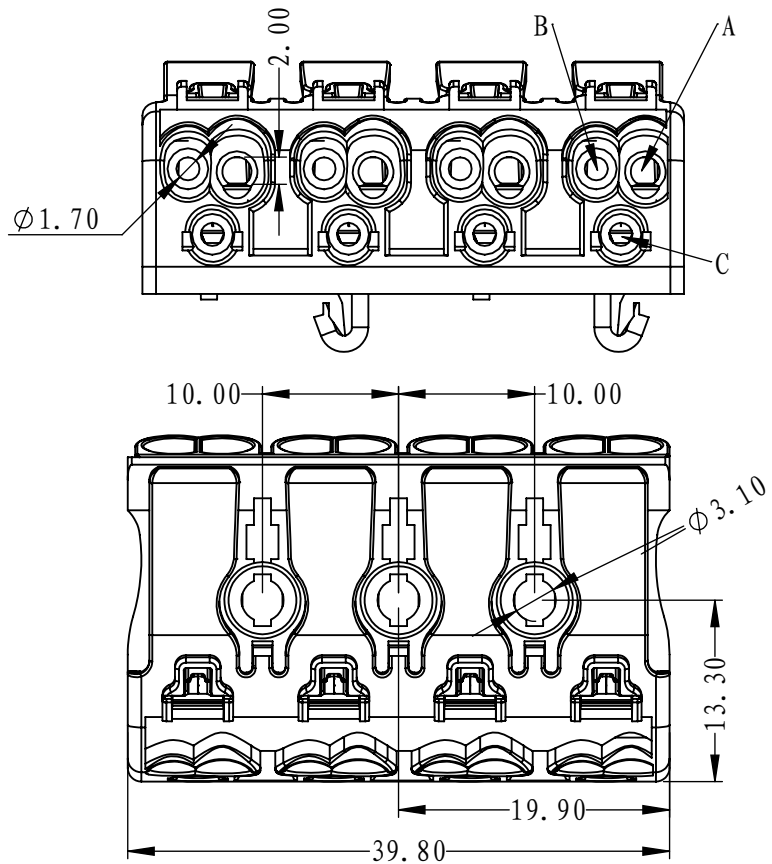
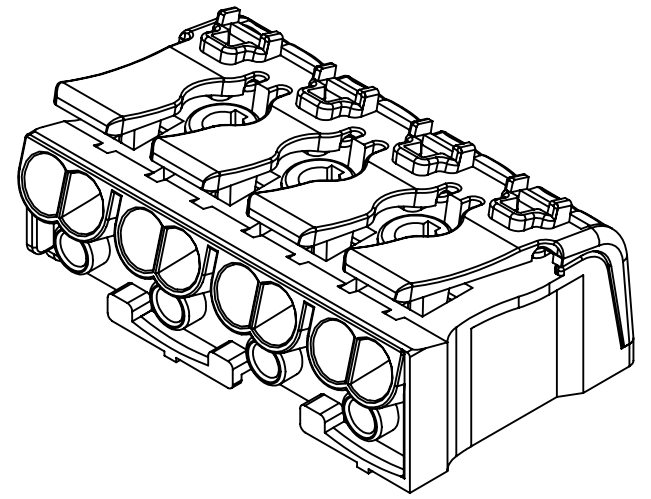
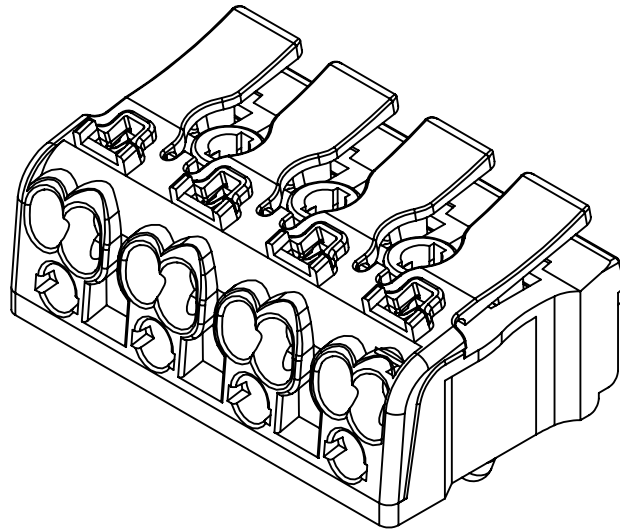
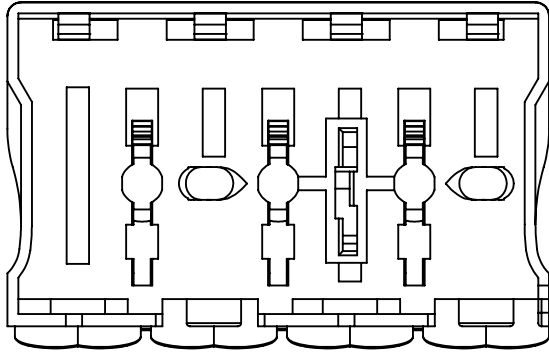

SERIAL NUMBER: Q/KR.C09-05-186

JIANGMEN KREALUX ELECTRICAL APPLIANCES CO., LTD				MODEL NO: P02-4J			
DRAWN		DATE		EDITION	A	SCALE	1.8:1